

---

charder®



**MS 2400**  
**Medical Scale**  
**USER MANUAL**

*Please keep the instruction manual at hand all the time for future reference.*

---

---

# **TABLE OF CONTENTS**

PREFACE.....	2
GENERAL INFORMATION .....	2
SAFETY INSTRUCTION .....	2
ENVIRONMENTAL.....	3
CLEANING.....	3
MAINTENANCE.....	3
WEIGHING OPERATION .....	4
WARRANTY-LIABILITY .....	4
DISPOSING OF THE SCALE.....	5
EXPLANATION OF THE GRAPHIC SYMBOLS .....	5
EMC GUIDANCE AND MANUFACTURER'S DECLARATION .....	7
SPECIFICATIONS.....	12
POWER ADAPTOR STANDARDS.....	13
KEY FUNCTIONS.....	14
FEATURE DESCRIPTION.....	15
INSTRUCTION FOR REPLACING BATTERY .....	16
ASSEMBLING BABY HEIGHT MEAS.-HM80D/80M .....	17
DIS-ASSEMBLING BABY HEIGHT MEAS.....	18
ERROR MESSAGE .....	19
TROUBLESHOOTING .....	20

## PREFACE

Thank you for choosing CHARDER MEDICAL product. All features of this product were designed to state of the art and are optimized for simple and straightforward use. If you have any queries or experience any problems not addressed in the operating instructions, please contact your CHARDER MEDICAL service partner, or visit us on the Internet at [www.chardermedical.com](http://www.chardermedical.com)

## GENERAL INFORMATION

We strongly recommend you use the scales on flat and hard surface. Any soft surface, like carpet will cause inaccuracy.

## SAFETY INSTRUCTION



Before putting the device into use, please read with care the information given in the Operating Instructions. They contain important instructions for installation, proper use and maintenance of the device.

The manufacturer shall not be liable for damages arising out of failure to heed the following instructions:

When using electrical components under increased safety requirements, always comply with the appropriate regulations.

Improper installation will render the warranty null and void.

Ensure the voltage marked on the power supply unit matches your mains power supply.

This device is designed for use indoors.

Observe the permissible ambient temperatures for use

The device meets the requirements for electromagnetic compatibility. Do not exceed the maximum values specified in the applicable standards.

These batteries should be kept away from small children. If swallowed, promptly seek medical assistance.

If you have any problem, contact your local CHARDER MEDICAL service partner.

Expected Service Life: 5 years

## ENVIRONMENTAL

All batteries contain toxic compounds; disposal of batteries should be delegated to a competent organisation, complying with the deposit of Poisonous Waste Regulation 1972.

Please do not incinerate batteries.

The optimum operating temperature for the scale is 5°C to +35°C; although it will operate at higher and lower temperatures the scales battery life will be adversely effected.

## CLEANING

We would recommend using alcohol based wipes or similar when cleaning the scales.

Please do not use large amounts of water when cleaning the scales as this will cause damage to the scales electronics, you should also refrain from using corrosive liquids or high pressure washers.

Always disconnect the scales from the mains power supply before cleaning.

## MAINTENANCE

The scale does not require any routine maintenance. However, we recommend checking the scale's accuracy at regular intervals. The regularity of these checks is dependent on the level of use and the state of the scale. If any inaccuracies occur, please contact your local

## WEIGHING OPERATION

Before reading detailed instructions on how to use all the weighing functions that are built into your scale, please read the following important guidelines:

Always be sure that the display shows `Zero` before use, if it does not then please press the ZERO key.

The Professional Medical scale is designed to detect when a stable weight is achieved, the indicator will `bleep` twice to indicate a stable weight value, your reading should be taken at this point.

## WARRANTY-LIABILITY

If a fault or defect is present on receipt of the unit which is within CHARDER MEDICAL's scope of responsibility, CHARDER shall have the right to either repair the fault or supply a replacement unit. Replaced parts shall be the property of CHARDER. Should the fault repairs or replacement delivery not be successful, the statutory provisions shall be valid. The period of warranty shall be two years, beginning on the date of purchase. Please retain your receipt as proof of purchase. Should your scale require servicing, please contact your dealer or CHARDER MEDICAL Customer Service.

No responsibility shall be accepted for damage caused through any of the following reasons: Unsuitable or improper storage or use, incorrect installation or commissioning by the owner or third parties, natural wear, changes or modifications, incorrect or negligent handling, overuse, chemical, electrochemical or electrical interference or humidity, unless this is attributable to negligence on the part of CHARDER MEDICAL.

If operating, climatic or any other influences lead to a major change in conditions or material quality, the treaty for perfect unit functioning shall be rendered null and void. If CHARDER provides an individual warranty, this means that the unit supplied will be free of faults for the length of the warranty period.

## DISPOSING OF THE SCALE

This product is not to be treated as regular household waste, but should be handed in to an electrical/electronic equipment recycling centre.

You can obtain further details from your local council, your municipal waste disposal company or the firm which you purchased the product.

## EXPLANATION OF THE GRAPHIC SYMBOLS

**SN-T13000001**

Designation of the serial number of every device, applied at the device.



(Number as an example)

“Please note the accompanying documents“

or “Observe operating instructions“



Identification of manufacturer of medical product including address

**Charder Electronic Co., Ltd.**

No.103, Guozhong Rd., Dali Dist.,

Taichung City 412, Taiwan (R.O.C.)



Type B applied parts.

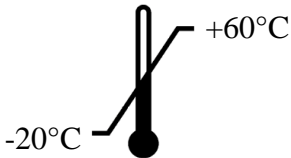

Dispose of old appliances separately from your household waste!!!

Instead, take them to communal collection points.

Carefully read this operation manual before setup and commissioning, even if you are already familiar with Charder scales.

Transport and storage temperature limit indicating the upper and the lower limit  
(Transport and storage temperature on packaging)

## EMC GUIDANCE AND MANUFACTURER'S DECLARATION

### Guidance and manufacturer's declaration-electromagnetic emissions

The digital weighing SCALE MS 2400 is intended for use in the electromagnetic environment specified below.  
The customer or the user of the digital weighing scale MS 2400 should assure that it is used in such an environment.

<b>Emission test</b>	<b>Compliance</b>	<b>Electromagnetic environment-guidance</b>
RF emissions CISPR 11	Group 1	The digital weighing scale_MS 2400 uses RF energy only for its internal function. Therefore, its RF emissions are very low and are not likely to cause any interference in nearby electronic equipment.
RF emissions CISPR 11	Class B	The digital weighing scale_MS 2400 is suitable for use in all establishments, including domestic establishments and those directly connected to the public low-voltage power supply network that supplies buildings used for domestic purposes.
Harmonic emissions IEC 61000-3-2	Class A	
Voltage fluctuations /flicker emissions IEC 61000-3-3	Compliance	



### Guidance and manufacturer's declaration-electromagnetic immunity

The digital weighing scale MS 2400 is intended for use in the electromagnetic environment specified below.

The customer or the user of the digital weighing scale MS 2400 should assure that it is used in such an environment.

Immunity test	IEC 60601 test level	Compliance level	Electromagnetic environment-guidance
Electrostatic discharge(ESD) IEC 61000-4-2	± 6 kV contact ± 8 kV air	± 6 kV contact ± 8 kV air	Floors should be wood, concrete or ceramic tile. If floors are covered with synthetic material, the relative humidity should be at least 30%
Electrical fast transient/burst IEC 61000-4-4	± 2kV for power supply lines + 1kV for input/output lines	± 2kV for power supply lines Not applicable	Mains power quality should be that of a typical commercial or hospital environment.
Surge IEC 61000-4-5	± 1kV line(s) to line(s) ± 2kV line(s) to earth	± 1kV differential mode Not applicable	Mains power quality should be that of a typical commercial or hospital environment.
Voltage Dips, short interruptions and voltage variations on power supply input lines IEC 61000-4-11	<5% UT(>95% dip in UT) for 0,5 cycle 40% UT(60% dip in UT) for 5 cycles 70% UT(30% dip in UT) for 25 cycles <5% UT(>95% dip in UT) for 5 s	<5% UT(>95% dip in UT) for 0,5 cycle 40% UT(60% dip in UT) for 5 cycles 70% UT(30% dip in UT) for 25 cycles <5% UT(>95% dip in UT) for 5 s	Mains power quality should be that of a typical commercial or hospital environment. If the user of the digital weighing scale requires continued operation during power mains interruptions, it is recommended that the digital weighing scale be powered from an uninterruptible power supply or a battery.

Power frequency(50/60 Hz) magnetic field IEC 61000-4-8	3 A/m	3 A/m	The digital weighing scale power frequency magnetic fields should be at levels characteristic of a typical location in a typical commercial or hospital environment.
NOTE UT is the a.c. mains voltage prior to application of the test level.			

<b>Guidance and manufacturer's declaration-electromagnetic immunity</b>			
The digital weighing scale MS 2400 is intended for use in the electromagnetic environment specified below. The customer or the user of the digital weighing scale_MS 2400 should assure that is used in such and environment.			
<b>Immunity test</b>	<b>IEC 60601 test level</b>	<b>Compliance level</b>	<b>Electromagnetic environment-guidance</b>
Conducted RF IEC 61000-4-6	3 Vrms 150 KHz to 80 MHz	3 Vrms	<p>Portable and mobile RF communications equipment should be used no closer to any part of the digital weighing scale MS 2400 including cables, than the recommended separation distance calculated from the equation applicable to the frequency of the transmitter.</p> <p><b>Recommended separation distance:</b>  <math>d = 1,2 \sqrt{P}</math>  <math>d = 1,2 \sqrt{P}</math> 80MHz to 800 MHz  <math>d = 2,3 \sqrt{P}</math> 800MHz to 2,5 GHz</p> <p>Where <math>P</math> is the maximum output power rating of the transmitter in watts (W) according to the transmitter manufacturer and <math>d</math> is the recommended separation distance in metres (m).</p>

Radiated RF IEC 61000-4-3	3 V/m 80MHz to 2,5 GHz	3 V/m	<p>Field strengths from fixed RF transmitters, as determined by an electromagnetic site survey<sup>a</sup>, should be less than the compliance level in each frequency range<sup>b</sup>.</p> <p>Interference may occur in the vicinity of equipment marked with the following symbol:</p> 
<p>NOTE1 At 80 MHz and 800 MHz, the higher frequency range applies.</p> <p>NOTE2 These guidelines may not apply in all situations. Electromagnetic propagation is affected by absorption and reflection from structures, objects and people.</p>			
<p>a Field strengths from fixed transmitters, such as base stations for radio (cellular/cordless) telephones and land mobile radios, amateur radio, AM and FM radio broadcast and TV broadcast cannot be predicted theoretically with accuracy. To assess the electromagnetic environment due to fixed RF transmitters, an electromagnetic site survey should be considered. If the measured field strength in the location in which the digital weighing scale is used exceeds the applicable RF compliance level above, the digital weighing scale should be observed to verify normal operation. If abnormal performance is observed, additional measures may be necessary, such as re-orienting or relocating the digital weighing scale.</p> <p>b Over the frequency range 150 kHz to 80 MHz, field strengths should be less than 3 V/m.</p>			

**Recommended separation distance between portable and mobile RF communications equipment and the digital weighing scale MS 2400**

The digital weighing scale MS 2400 is intended for use in an electromagnetic environment in which radiated RF disturbances are controlled. The customer or the user of the digital weighing scale MS 2400 can help prevent electromagnetic interference by maintaining a minimum distance between portable and mobile RF communications equipment (transmitters) and the digital weighing scale as recommended below, according to the maximum output power of the communications equipment.

Rated maximum output power of transmitter  W	Separation distance according to frequency of transmitter m		
	150 kHz to 80 MHz  $d = 1,2\sqrt{P}$	80 MHz to 800 MHz  $d = 1,2\sqrt{P}$	800 MHz to 2,5 GHz  $d = 2,3\sqrt{P}$
0,01	0,12	0,12	0,23
0,1	0,38	0,38	0,73
1	1,2	1,2	2,3
10	3,8	3,8	7,3
100	12	12	23



For transmitters rated at a maximum output power not listed above, the recommended separation distance d in metres (m) can be estimated using the equation applicable to the frequency of the transmitter, where p is the maximum output power rating of the transmitter in watts (W) according to the transmitter manufacturer.

NOTE1 At 80 MHz and 800 MHz, the separation distance for the higher frequency range applies.  
 NOTE2 These guidelines may not apply in all situations. Electromagnetic propagation is affected by absorption and reflection from structures, objects and people.

## SPECIFICATIONS

<b>Model#</b>	MS 2400
<b>Capacity</b>	20 kg x 10 g, 44 lb x 0.02 lb, 704 oz x 0.5 oz
<b>Accuracy</b>	±20g , ±0.04lb , ±1.0oz
<b>Weight units</b>	kg, lb, oz, lb:oz
<b>Operating Temp. &amp; Humidity</b>	+5°C - +35°C 15% - 85% RH
<b>Transport / Storage Temp. &amp; Humidity</b>	- 20°C ... + 60°C 10% - 95% RH
<b>LCD Display</b>	Easy to read 1.0" LCD display with 4 1/2 digits
<b>Dimension</b>	Scale with handle: 24 x 14 x 2 in. (620 x 350 x 50 mm) Platform surface: 20 x 14 x 2 in. (500 x 350 x 50 mm)
<b>Key Function</b>	ON/ZERO/OFF, kg / lb, MEMORY
<b>Power Supply</b>	9V battery / 9V -12 V adaptor

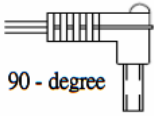
## POWER ADAPTOR STANDARDS

AMP VOLTAGE	DRAWING NO.:	CE APPROVED TYPE NO. / MODEL NO.:	TYPE	
9V DC 100mA	AD-0484	D35W090100-23/1	US	 <p>90 - degree</p>
9V DC 100mA	AD-038A	D41W1090100-13/1	EU	
9V DC 100mA	AD-037A	D41WK090100-23/2	UK	
9V 200mA	AD-8082(AD-0544)	UE05WCP-090020SPC	US	
9V 200mA	AD-8082(AD-0544)	UE05WCP-090020SPC	EU	
9V 200mA	AD-8082(AD-0544)	UE05WCP-090020SPC	UK	
9V 200mA	AD-8082A(AD-0544A)	UE05WCP-090020SPC	AU	
15V 300mA	AD-016D	D41W150300-13/1	US	
15V 300mA	AD-0420	D41W150300-13/1	EU	
15V 300mA	AD-0370	D41WK150300-23/2	UK	
15V 300mA	AD-0482	D41WA150300-13/2	AU	
15V300mA	AD-8079D(AD-0536D)	UE05WCP-150030SPC	US	
15V300mA	AD-8079A(AD-0536A)	UE05WCP-150030SPC	EU	
15V300mA	AD-8079B(AD-0536B)	UE05WCP-150030SPC	UK	
15V300mA	AD-8079C(AD-0536C)	UE05WCP-150030SPC	AU	
12V 1A	AD-8084B	UE24WV-120100SPA	EU	
12V 1A	AD-8084	UE24WB-120100SPA	UK	
12V 1A	AD-8095	UE24WCP1-120100SPA	US	
12V 1A	AD-8095	UE24WCP1-120100SPA	EU	
12V 1A	AD-8095	UE24WCP1-120100SPA	UK	
12V 1A	AD-8095	UE24WCP1-120100SPA	AU	
12V 2A	AD-8058(AD-0521)	UE24WU-120200SPA	US	
12V 2A	AD-8057(AD-0520)	UE24WV-120200SPA	EU	
12V 2A	AD-8056(AD-0519)	UE24WB-120200SPA	UK	
12V 2A	AD-8074(AD-0534)	UE24W4-120200SPAS	AU	
12V 1A	AD-8096	UE24WCP1-120100SPA	US	 <p>180 - degree</p>
12V 1A	AD-8096	UE24WCP1-120100SPA	EU	
12V 1A	AD-8096	UE24WCP1-120100SPA	UK	
12V 1A	AD-8096	UE24WCP1-120100SPA	AU	
12A 1.5A	AD-8025A(AD-0527)	GFP181DA-120150B-2	US	
12A 1.5A	AD-8025D(AD-0529)	GFP181DA-120150B-2	UK	

## KEY FUNCTIONS

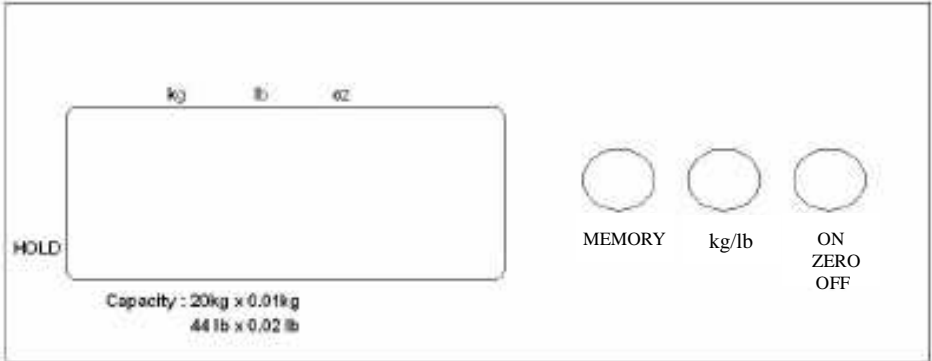

### Key Functions

#### ON/ZERO/OFF

- Power on and power off.
- Press to ZERO the weight of subject.
- Press 3 seconds to power off.
- Press to TARE the weight when the weight is at 2% of full capacity.

#### kg/lb

- Press this key to switch unit between kg, lb, oz, and lb: oz.

#### MEMORY

- Press to recall and release the weighing value.
- If the weight is less than 1kg, press this key to recall the stored value of weight. If the weight is greater than 1kg, press this key to store the weight value

## FEATURE DESCRIPTION

### MEMORY

When power on, the Memory feature will auto switch on and the arrow besides HOLD at left bottom of LCD will flicker.

When the loaded weight is above 1kg and stable, the arrow stops flickering.

To disable the Memory function, please press ON/ZERO/OFF key again.

### TARE

TARE only works under 400g. When weight of subject is under 400g, press [ON/ZERO/OFF] key to tare the weight. When the arrow of hold flickered, the TARE feature is working now. Put your tare object on the scale and start weighing, then remove the tare object again. Wait for the display to return zero, and put the baby to be weighed together with the tare object.



# INSTRUCTION FOR REPLACING BATTERY

## STEP 1.



### LOCATE THE BATTERY COVER

## STEP 2.



## STEP 3.

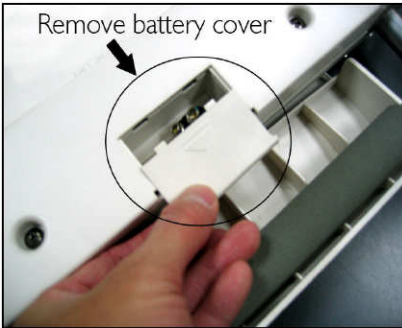

## STEP 4.

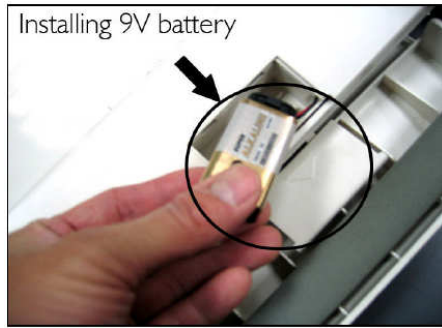

## STEP 5.

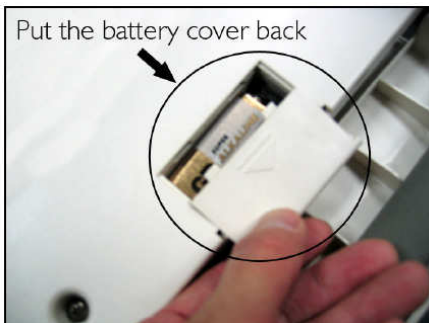

## ASSEMBLING BABY HEIGHT MEAS.-HM80D/80M

1. Place the bracket and tighten the screw with screw driver.

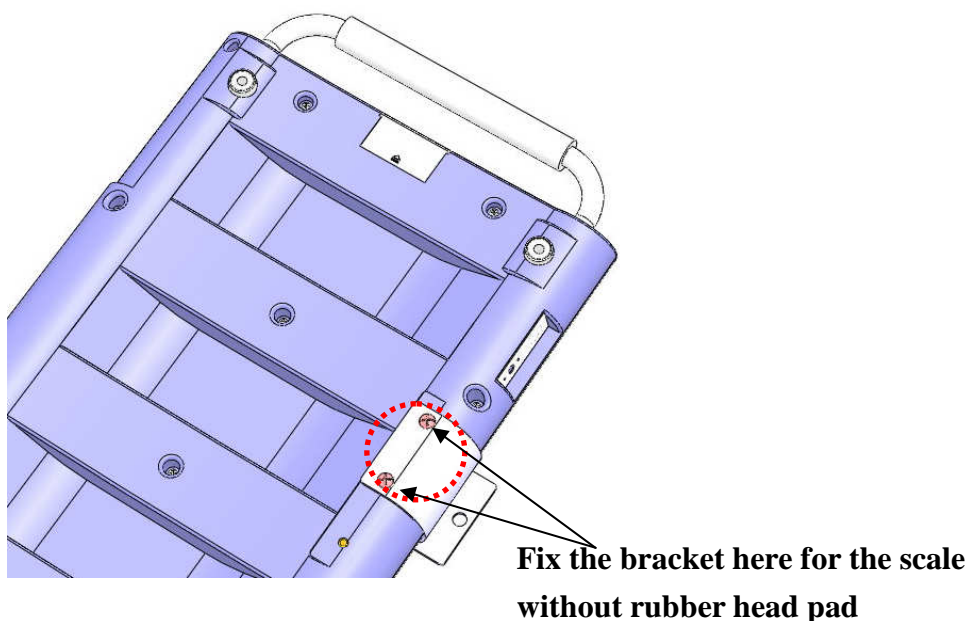
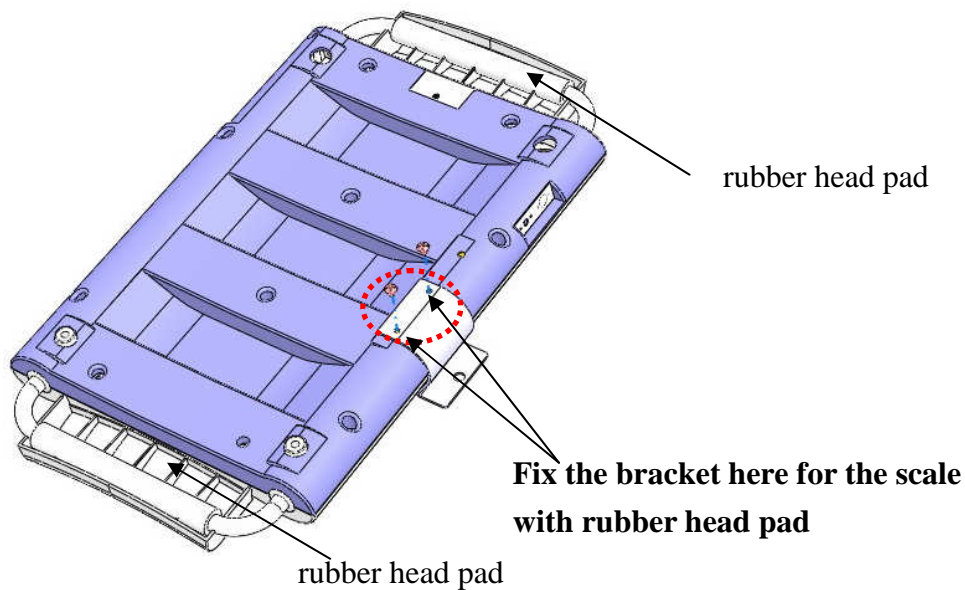

Place the baby height meas. (HM-80M or HM-80D). properly on the bracket and click it.

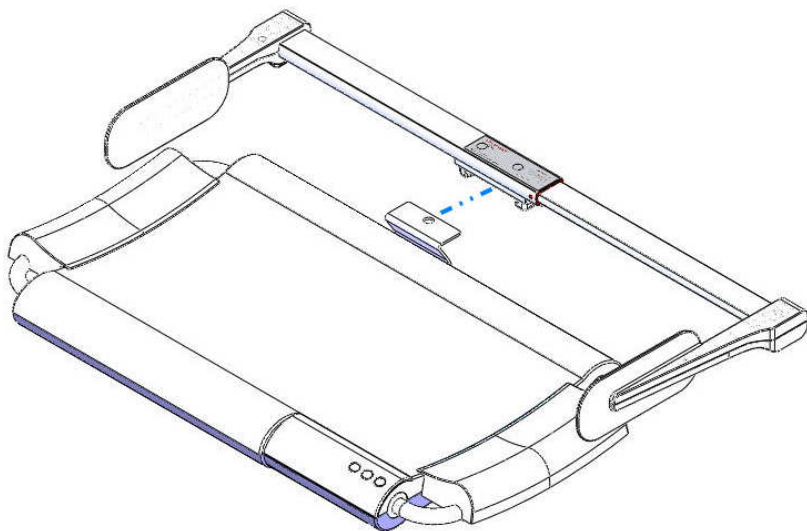

## DIS-ASSEMBLING BABY HEIGHT MEAS.

Find the buckle at the back of baby height measurement.  
Depressing buckle and remove the height measurement gently from the bracket.

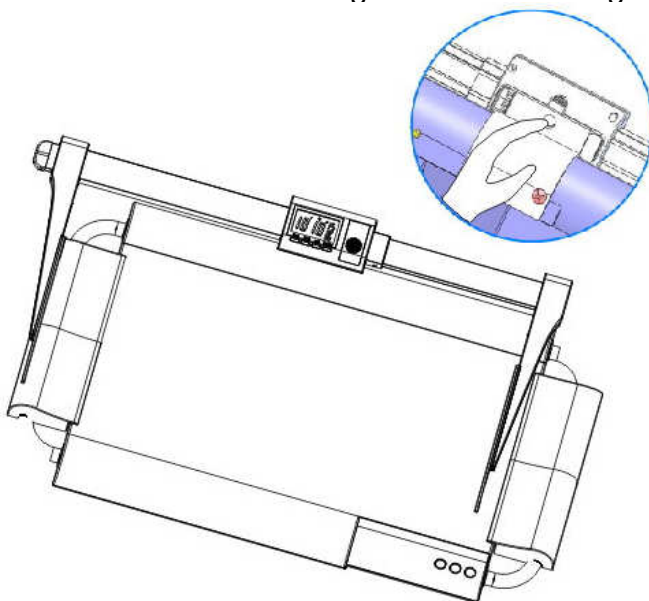

## ERROR MESSAGE

### ■ LOW BATTERY

If battery is discharged, the display will show LOW. The operator should replace the battery.



### ■ OVER ZERO

If zero count is higher than the setting range, the display will show “Err” message. The scale will turn off in 30 seconds if the status continues.

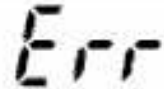

### ■ UNDER ZERO

If zero count is below the setting range, the display will show “ErrL” message. The scale will turn off in 30 seconds if the status continues.

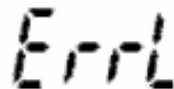

### ■ OVERLOAD

If the total load exceeds the maximum capacity of the scale, the display will show “Err” message. The weight must be removed immediately from the surface.

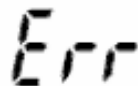

## TROUBLESHOOTING

### **Troubleshooting for defective modes:**

Original purchaser can enjoy the benefits under the effective Warranty against functional defects in material and workmanship subject to the terms and conditions listed in the yearly Warranty Program & Return Policy.

Our warranty service program includes the following:

1. Technician repair service under warranty or at a service maintenance charge depending on the workmanship for the defective functionality or cause of damage covered by the warranty.
2. Parts replacement from the manufacturing factory under the warranty or at a certain cost for the replaced parts plus the workmanship charge if not covered under the warranty.

Before you contact our Authorized Dealer in your country for technician repair service, please read through the following section carefully:

### **Self-checking Tips:**

Some functional defects can be identified and maintained by users as listed below:

#### **1. Power-on failure**

- Check if the main power adaptor has not plugged onto the scale properly
- Check if the battery power is running low - Replace with new batteries

#### **2. Indicator showing “0000” ZERO SPAN out of range**

- Incorrect weighing result - Avoid damages by external

---

environment force such as free-drop to the ground, collision by external objects, etc.

- Proper re-calibration procedure required to correct the setting of weighing accuracy.
- Interference due to RF disturbance, ground vibration...etc.
- Unstable platform feet adjustments according to bubble level indication
- Incorrect position or other external objects within weighing area
- The weighing-scale is not put in a solid & firm ground area, such as carpet floor or lawn.

**In case of the following defective mode occurs, it is suggested to contact your nearest Authorized Dealer for further technician service & repair:**

## **1. POWER switch-on failure :**

- Push-button faulty
- Short circuit wires - Wire broken
- Safety fuse burnt out
- Wire connection problem
- Main power adaptor faulty – Parts Replacement

## **2. LCD display faulty**

- Possible hardware defects include: Uneven brightness in the LCD display screen & texts color blurred, smeared rainbow screen, incorrect decimal display
- LCD PIN broken or short circuit
- PCB cooper foil broken & loosed welding
- Unable to save or read data – IC or transistor faulty, internal parts broken.
- LCD showing “ERRL” after switch on - Load cell damaged
- Overload may cause the weigh to malfunction.

- 
- Software system crash
  - Resonator faulty
  - Load cells with faulty grinding standard.
  - Key buttons failure - Front key panel damaged or disconnected

### **3. Buzzer malfunction**

- Wrong welding of PVC wire
- Key buttons & control panel damaged or disconnected.

# Manufacturer's Declaration of Conformity

This product has been manufactured in accordance with the harmonized European standards, following the provisions of the below stated directives:

	93/42/EEC as amended by 2007/47/EC Medical Device Directive
--	--

*Please see separate document showing on sticker of device for above CE marking.*

Authorized EU Representative:



**Wellkang Ltd**  
Suite B, 29 Harley Street  
LONDON, W1G 9QR, U.K.

Manufactured by:



Charder Electronic Co., Ltd.  
No.103, Guozhong Rd., Dali Dist.,  
Taichung City, 412 Taiwan (R.O.C.)

FDA no.: D072479